



Installation and Operation Instructions RH Room Series

PLEASE READ INSTRUCTIONS CAREFULLY BEFORE INSTALLATION!

GENERAL INFORMATION

The RH Room transmitter is a Relative Humidity transmitter that can be powered with either an AC or DC supply voltage. The transmitter can also include an optional temperature sensor for monitoring the space temperature.

All units are shipped from the factory set up with a 4-20 mA output. The RH Room transmitter is field selectable with a 4-20 mA, 0-5 VDC, or 0-10 VDC output signal that is equivalent to 0 to 100% RH.

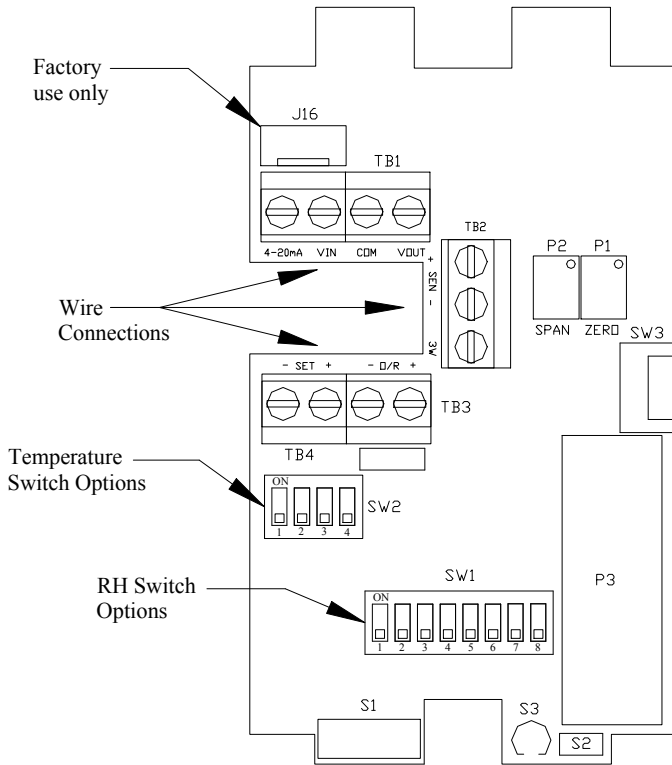

Figure #1

MOUNTING INSTRUCTIONS

Separate the cover from the base. Attach the base directly to the wall or to a standard 2" x 4" junction box. Refer to the wiring instructions to make necessary connections. After wiring, attach the cover to the base by snapping the top of the cover on first and then the bottom.

WIRING INSTRUCTIONS

A 16 to 22 AWG shielded cable is recommended for all transmitters. Twisted pair may be used for 2-wire current output transmitters. Refer to **Figure #2** for RH wiring diagrams. Refer to **Figure #5** for optional temperature sensor wiring diagrams.

Caution:

- **It is recommended that you use an isolated UL-listed Class 2 transformer when powering the unit with 24 VAC. Failure to wire the devices with the correct polarity when sharing transformers may result in damage to any device powered by the shared transformer.**
- **Remove power before wiring. Never connect or disconnect wiring with power applied.**
- **When using shielded cable, ground the shield only at the controller end. Grounding both ends can cause a ground loop.**

2 Wire Current Output Signal

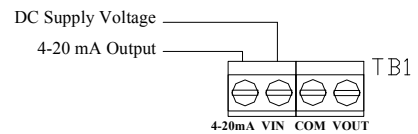

3 Wire Current Output Signal

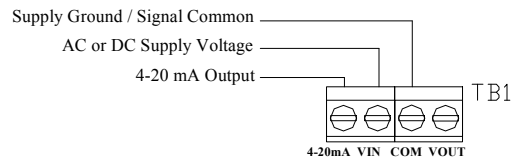

Voltage Output Signal

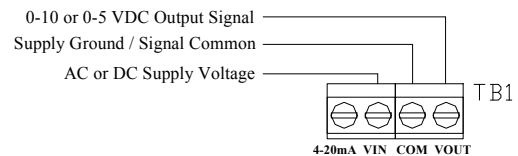

Figure #2

OUTPUT SELECTIONS

Switches 6, 7, and 8 are used to set the RH output signal. Refer to **Figure #3** for switch settings.

Output Selection Switches (SW1)

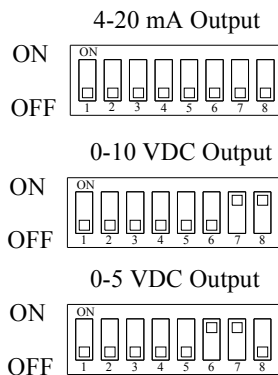

Figure #3

REVERSE ACTING OUTPUT

The output can be changed to reverse acting mode. The output range stays the same but the corresponding RH value is opposite.

Example: Direct Acting (DA)

0-10V output mode,
0V = 0% RH and 10V = 100% RH

Reverse Acting (RA)

0-10V output mode,
0V = 100% and 10V = 0%

To change the transmitter to reverse acting or back to direct acting, set switch 4 ON to put the unit in setup mode. After switch 4 is on, switch 2 will put the unit in direct/reverse acting mode. When switch 2 is set to ON, the output can be used to show if the unit is in direct or reverse acting mode. For direct acting the output will be 1V for 0-5V, 2V for 0-10V, and 7.2mA for 4-20mA. For reverse acting the output will be 4V for 0-5V, 8V for 0-10V, and 16.8mA for 4-20mA.

With switches 2 and 4 ON, each time switch 5 is set to ON the output will change to reverse acting or direct acting.

To reset the unit to the default setting, toggle both switches 5 and 6 ON then OFF while both switches 2 and 4 are ON.

When all calibration is completed, remember to place the switches back into the positions that correspond to the output needed as shown in **Figure #3**.

RH CALIBRATION INSTRUCTIONS

Note: This is only a single point calibration. All transmitters are factory calibrated to meet/exceed published specifications. Field adjustment should not be necessary.

The dipswitch allows the user to calibrate the sensor through the software. Setting switch 4 ON will put the transmitter into setup mode allowing the increment and decrement to work. Once in setup mode, the output will change to 50% (2.5V for 0-5V, 5V for 0-10V, 12mA for 4-20mA). Each increment or decrement step will cause the output to change by 0.1V for 0-5V, 0.2V for 0-10V, and 0.32mA for 4-20mA in setup mode. This can be used to show the user how far offset the transmitter is. To see the starting point again set switch 1 ON. This will show the 50% output again. When the unit is out of setup mode the output will go back to RH output.

Increment RH Output

This will shift the RH output linearly up in 0.5% steps. Switch 4 must be set to ON first. After switch 4 is on, each time switch 5 is set ON the RH output will increase by 0.5%. The increase goes into effect each time switch 5 is set to ON.

Decrement RH Output

This will shift the RH output linearly down in 0.5% steps. Switch 4 must be set to ON first. After switch 4 is on, each time switch 6 is set ON the RH output will decrease by 0.5%. The decrease goes into effect each time switch 6 is set to ON.

Reset RH Output

This will reset the RH output back to the original calibration. Switch 4 must be set to ON first. After switch 4 is on, toggle switches 5 and 6 ON then OFF. After 5 and 6 are OFF slide switch 4 OFF.

When all calibration is completed, remember to place the switches back into the positions that correspond to the output needed as shown in **Figure #3**.

Note: Potentiometers P1 (Zero) and P2 (Span) in Figure #1 are not used for RH sensor calibration. They are used for factory use only!

TEST INSTRUCTIONS

Test mode will make the transmitter output a fixed 0%, 50%, or 100% value. The sensor will not affect the transmitter output. This is used for troubleshooting or testing only.

Switches 1, 2, and 3 are used for test mode. The output will be a fixed 0%, 50%, or 100% signal that corresponds to the output selected with switches 6, 7, and 8. Refer to **Figure #4** for switch settings.

Test Selection Switches (SW1)

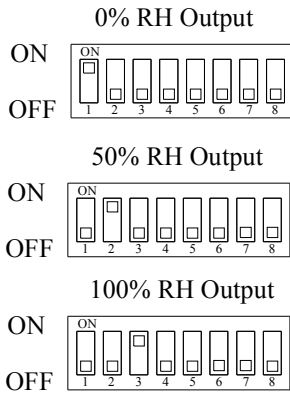
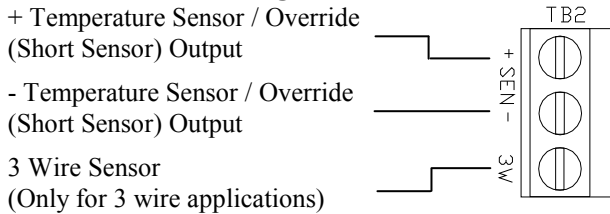

Figure #4

TEMPERATURE WIRING DIAGRAMS

2-Wire Resistive Sensors

Figure #5



AD592 or LM334 Current Sensor

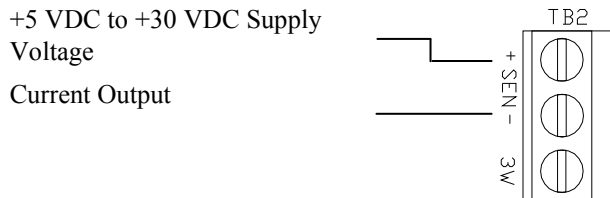

AD592, LM334, or LM34 Voltage Output

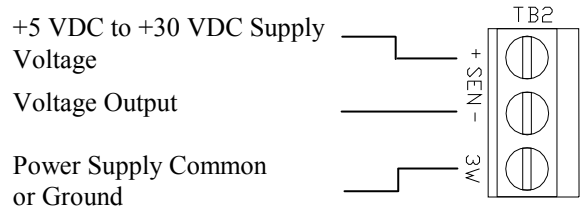

Setpoint and Override Wiring

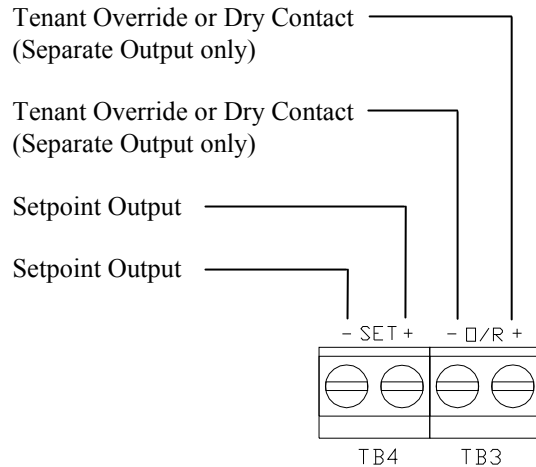

Setpoint and Override Common Ground Wiring

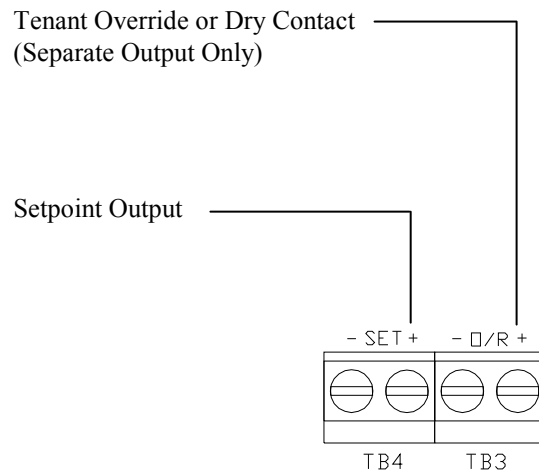

TEMPERATURE DIPSWITCH DIAGRAMS

OVERRIDE SHORTS SENSOR

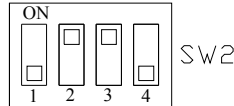

OVERRIDE SEPARATE INPUT

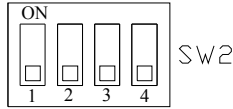

SETPOINT IN SERIES WITH SENSOR, OVERRIDE SEPARATE INPUT

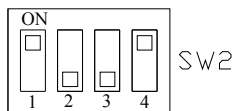

SETPOINT IN SERIES WITH SENSOR, OVERRIDE SHORT SENSOR

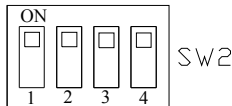

COMMON GROUND OVERRIDE SHORTS SENSOR

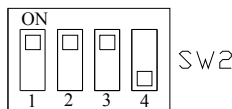

COMMON GROUND OVERRIDE SEPARATE INPUT

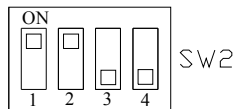

RH CONVERSION FORMULAS

To convert output signal to percent RH:

4-20 mA

$(\text{mA signal}) - 4 / 0.16 = \text{percent RH}$

Example: 12mA output signal

$(12-4) / 0.16 = 50\% \text{ RH}$

0-5 VDC

$(\text{VDC signal}) / 0.05 = \text{percent RH}$

Example: 1.25vdc output signal

$1.25 / 0.05 = 25\% \text{ RH}$

0-10 VDC

$(\text{VDC signal}) / 0.10 = \text{percent RH}$

Example: 7.50vdc output signal

$7.50 / 0.10 = 75\% \text{ RH}$

TROUBLESHOOTING

Problem:

No Reading

- Check that you have the correct supply voltage at the power terminal blocks.
- Check that wiring configurations and all DIP switch settings are as in **Figures #2 and #3**.
- Verify that the terminal screws are all connected tightly and that all of the wires are firmly in place.

Erratic Readings

- Verify that all of the wires are terminated properly.
- Make sure that there is no condensation on the board.
- Check that the input power is clean. In areas of high RF interference or noise, shielded cable may be necessary to stabilize signal.

Inaccurate Readings

- If you suspect that the transmitter is not reading within the specified tolerance, please contact the factory for further assistance.



PRODUCT SPECIFICATIONS

Supply Voltage	4-20mA Output: 250 Ohm Load 15 - 40 VDC / 18 - 28 VAC	RH Measurement Range	0 - 100%
	4-20mA Output: 500 Ohm Load 18 - 40 VDC / 18 - 28 VAC (500 Ohm Load Max)	RH Accuracy @ 77°F (25°C)	± 2%, 3%, or 5% from 20 to 95% RH
	0-5 VDC Output: 12 - 40 VDC / 18 - 28 VAC (4K Load Minimum)	Repeatability	Less than 0.5%
	0-10 VDC Output: 18 - 40 VDC / 18 - 28 VAC (4K Load Minimum)	Operating Humidity Range	0 to 95% RH non-condensing
Supply Current	Voltage Output: 8mA Max Current Output: 24mA Max	Operating Temp. Range	32 to 122°F (0 to 50°C)
RH Output	2-Wire, 4 - 20 mA	Storage Temp. Range	-40 to 160°F (-40 to 71°C)
	3-Wire, 0 - 5VDC, 0 - 10VDC, or 4-20mA		

2305 Pleasant View Rd. ● Middleton Industrial Park ● Middleton, WI 53562

PH: (608) 831-2585 ● FAX (608) 831-7407

www.workaci.com